

# mini

OEM

HVAC + R



## MAIN FUNCTIONS

REFRIGERATION

CLIMATIZATION

SPECIAL FUNCTIONS

## CHARACTERISTICS

- 7 segment LED Display
- Client Logo on the panel (optional)
- Great Cost X Benefit
- Function Hourmeters
- Custom Design
- Customized Functions
- One Wire Communication (optional)

- Backlit Buttons
- Bluetooth and Wi-Fi Modules Interface
- Integrated or remote I/Os (ECU)
- USB interface through ECU (optional)
- Telematics through additional module
- Two temperature scales (°F or °C)
- Metallic or plastic housing

## AVAILABLE FOR



# COMPACT PANEL, POTENT AIR CONDITIONING CONTROL PANEL.

## INTERFACE POSITIONS

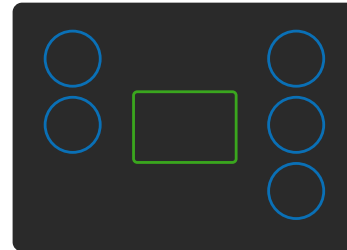

mini

## DISPLAY

- LED DISPLAY
- 7 segment LED Display
- Selectable temperature scale °F or °C
- 10 Languages



## BUTTONS

- 5 BUTTON KEYBOARD
- On/Off Function
- 2 button adjustments
- Fresh Air
- VENTILATION CONTROL
- AIR CONDITIONING CONTROL



## CONFIGURATION OPTIONS

INPUTS: Analog and Digital

OUTPUTS: Negative Digitals or through external ECU: Analogs, Positive Digitals, Bridge (flap motor) and PWM

COMMUNICATION: ECU Module or Telematics Module

## FUNCTIONS UNDER REQUEST



WI-FI



BLUETOOTH



CELL PHONE  
INTERFACE



CAN BUS



REMOTE I/O  
NETWORK



DATA  
LOGGER



CUSTOMIZABLE  
INTERFACES



## TECHNICAL DATA

HVAC + R

**mini**  
METALLIC

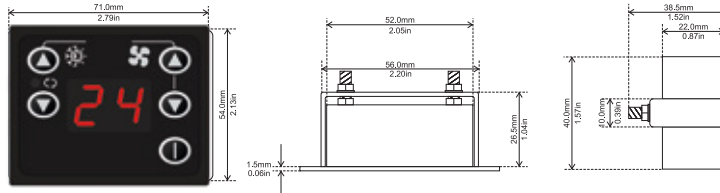

Approximated weight: 120g

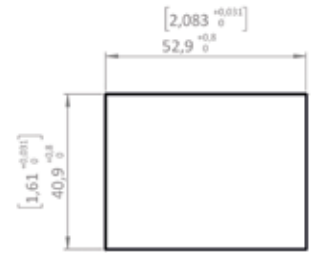

SUGGESTED PANEL CUT OUT:  
MINIMUM THICKNESS = 1,2 mm [0,047 in]  
MAXIMUM THICKNESS = 3,5 mm [0,138 in]

**mini**  
PLASTIC

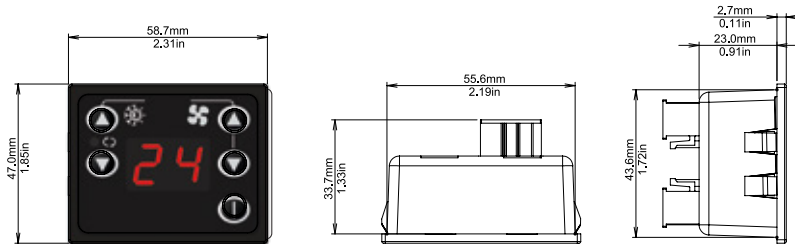

Approximated weight: 50g

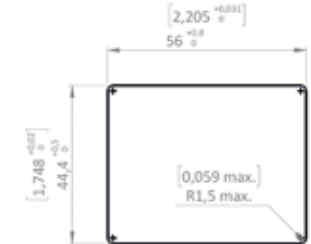

SUGGESTED PANEL CUT OUT:  
MINIMUM THICKNESS = 1,2 mm [0,047 in]  
MAXIMUM THICKNESS = 2,5 mm [0,098 in]

## CONNECTORS



MINI-FIT 6 ways  
Part Number: 39-01-2060  
Terminal - PN: 39-00-0038  
Manufacturer: Molex



MINI-FIT 8 ways  
Part Number: 39-01-2080  
Terminal - PN: 39-00-0038  
Manufacturer: Molex

### TECHNICAL DATA

TECHNICAL DATA	
OPERATING VOLTAGE	12 VDC / 24 VDC
OPERATING VOLTAGE RANGE	10 VDC to 30 VDC
MAXIMUM VOLTAGE	32 VDC during 5 min
MAXIMUM CURRENT PER OUTPUT	500mA
OUTPUT SHORT-CIRCUIT	Protected
REVERSE POLARITY	Protected
OPERATING TEMPERATURE RANGE	-40°C to +85°C / -40°F to +185°F (Normal or extended temperature range options)
STORAGE TEMPERATURE	-40°C to +85°C / -40°F to +185°F
TEMPERATURE SENSOR	NTC (Other types under request)
FRONTAL PROTECTION DEGREE	IP 54
COMMUNICATION	One Wire / CAN Bus
MAXIMUM CURRENT CONSUMPTION	12 VDC @ 20mA / 24 VDC @ 25mA *
STANDBY CONSUMPTION	N/A

\* Consumption may vary according to customer specifications.  
We keep the right to update or change information regarding products without prior notice.

# mini

## 7 SEGMENT DISPLAY AIR CONDITIONING CONTROL PANEL

GL-M334

- Return sensor input
- Pressure Switch input (digital) - GL M334
- Coil temperature sensor input - GL-POHGL334
- 3 speed evaporator output
- Compressor/Condenser output
- Heating output
- Fresh Air output
- Plastic housing

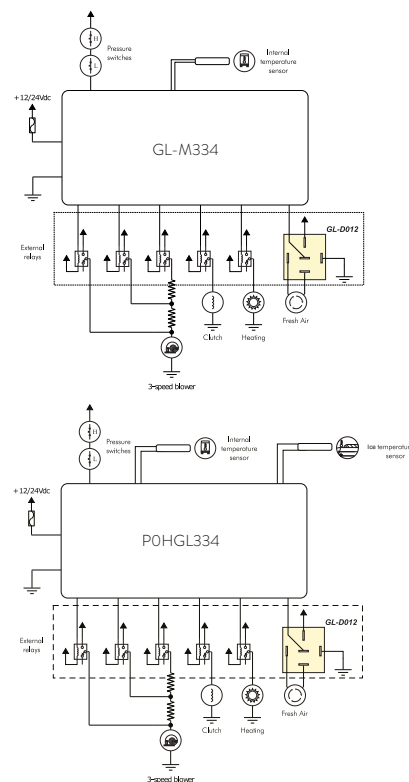

## AIR CONDITIONING CONTROL PANEL, 7 SEGMENT LED DISPLAY

GL-G435

- PWM Ventilation (6 speeds)
- Pressure Switch Input (digital)
- Return Temperature Sensor
- Metallic housing

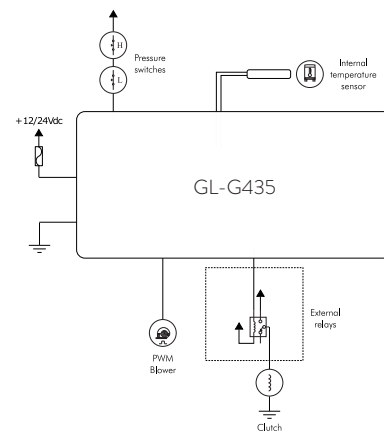

Choose the best options for your system

PIN CN1	MINI   POSSIBLE CONFIGURATIONS - HARDWARE 1		
1	DIGITAL OUTPUT NEGATIVE 0.5A	OR	--
2	DIGITAL OUTPUT NEGATIVE 0.5A	OR	--
3	DIGITAL OUTPUT NEGATIVE 0.5A	OR	(*)
4	DIGITAL OUTPUT NEGATIVE 0.5A	OR	ONE WIRE
5	DIGITAL OUTPUT NEGATIVE 0.5A	OR	--
6	DIGITAL OUTPUT NEGATIVE 0.5A	OR	--
PIN CN2			
1	GND	OR	--
2	GND	OR	--
2	GND	OR	--
4	GND	OR	--
5	ANALOG INPUT	OR	DIGITAL INPUT
6	ANALOG INPUT	OR	DIGITAL INPUT
7	ANALOG INPUT	OR	DIGITAL INPUT
8	POWER SUPPLY	OR	--

(\*) When using ONE WIRE communication you cannot use this output.

PIN	MINI   POSSIBLE CONFIGURATIONS - HARDWARE 2		
1	GND	OR	--
2	GND	OR	--
3	GND	OR	--
4	ONE WIRE	OR	--
5	ANALOG INPUT	OR	DIGITAL INPUT
6	ANALOG INPUT	OR	DIGITAL INPUT
7	POWER SUPPLY	OR	--
8	POWER SUPPLY	OR	--

PIN CN1	MINI   POSSIBLE CONFIGURATIONS - HARDWARE 3		
1	DIGITAL OUTPUT POSITIVE 0.5A	OR	--
2	DIGITAL OUTPUT POSITIVE 0.5A	OR	--
3	DIGITAL OUTPUT POSITIVE 0.5A	OR	--
4	DIGITAL OUTPUT POSITIVE 0.5A	OR	--
5	DIGITAL OUTPUT POSITIVE 0.5A	OR	--
6	DIGITAL OUTPUT POSITIVE 0.5A	OR	--
PIN CN2			
1	GND	OR	--
2	GND	OR	--
3	GND	OR	--
4	GND	OR	--
5	ANALOG INPUT	OR	DIGITAL INPUT
6	ANALOG INPUT	OR	DIGITAL INPUT
7	ANALOG INPUT	OR	DIGITAL INPUT
8	POWER SUPPLY	OR	--

# PRODUCT CONFIGURATION

PIN CN1	MINI   POSSIBLE CONFIGURATIONS - HARDWARE 4				
1	DIGITAL OUTPUT NEGATIVE 0.5A	OR	--	OR	--
2	DIGITAL OUTPUT NEGATIVE 0.5A	OR	--	OR	--
3	DIGITAL OUTPUT NEGATIVE 0.5A	OR	--	OR	--
4	DIGITAL OUTPUT NEGATIVE 0.5A	OR	--	OR	--
5	DIGITAL OUTPUT NEGATIVE 0.5A	OR	--	OR	--
6	DIGITAL OUTPUT NEGATIVE 0.5A	OR	--	OR	--
PIN CN2					
1	GND	OR	--	OR	--
2	GND	OR	--	OR	--
2	GND	OR	--	OR	--
4	GND	OR	--	OR	--
5	ANALOG INPUT	OR	DIGITAL INPUT	OR	--
6	ANALOG INPUT	OR	DIGITAL INPUT	OR	--
7	ANALOG INPUT	OR	DIGITAL INPUT	OR	ONE WIRE
8	POWER SUPPLY	OR	--	OR	--

PIN CN1	MINI   POSSIBLE CONFIGURATIONS - HARDWARE 5				
1	DIGITAL OUTPUT NEGATIVE 0.5A	OR	--	OR	--
2	DIGITAL OUTPUT NEGATIVE 0.5A	OR	--	OR	--
3	DIGITAL OUTPUT NEGATIVE 0.5A	OR	--	OR	--
4	DIGITAL OUTPUT NEGATIVE 0.5A	OR	PWM OUTPUT	OR	--
5	DIGITAL OUTPUT NEGATIVE 0.5A	OR	--	OR	--
6	DIGITAL OUTPUT NEGATIVE 0.5A	OR	PWM OUTPUT	OR	--
PIN CN2					
1	GND	OR	--	OR	--
2	GND	OR	--	OR	--
2	GND	OR	--	OR	--
4	GND	OR	--	OR	--
5	ANALOG INPUT	OR	DIGITAL INPUT	OR	--
6	ANALOG INPUT	OR	DIGITAL INPUT	OR	--
7	ANALOG INPUT	OR	DIGITAL INPUT	OR	ONE WIRE
8	POWER SUPPLY	OR	--	OR	--



WE ARE TODAY.  
WE ARE TOMORROW.  
WE ARE GLOBUS!



**Globus**  
Electronics



Av.Pernambuco, 106 | Navegantes | Porto Alegre | Brasil  
Fone: +55 51 3205 0555



Phone: +1 754 600 9882

[www.globuselectronics.com](http://www.globuselectronics.com)

